



INTAKE SYSTEM

INSTALLATION INSTRUCTIONS

21-886C

KIA / HYUNDAI

2021-25 Sorento

2021-26 Santa Fe

2022-26 Santa Cruz

L4-2.5L Turbo

NOT LEGAL FOR SALE OR USE ON ANY POLLUTION CONTROLLED MOTOR VEHICLE IN CALIFORNIA OR STATES ADOPTING CALIFORNIA EMISSION PROCEDURES.

See aemintakes.com for CARB status on each part for a specific vehicle

TOOLS NEEDED:

- Ratchet
- Extension
- 10mm socket
- 4mm allen
- 10mm wrench
- cutters

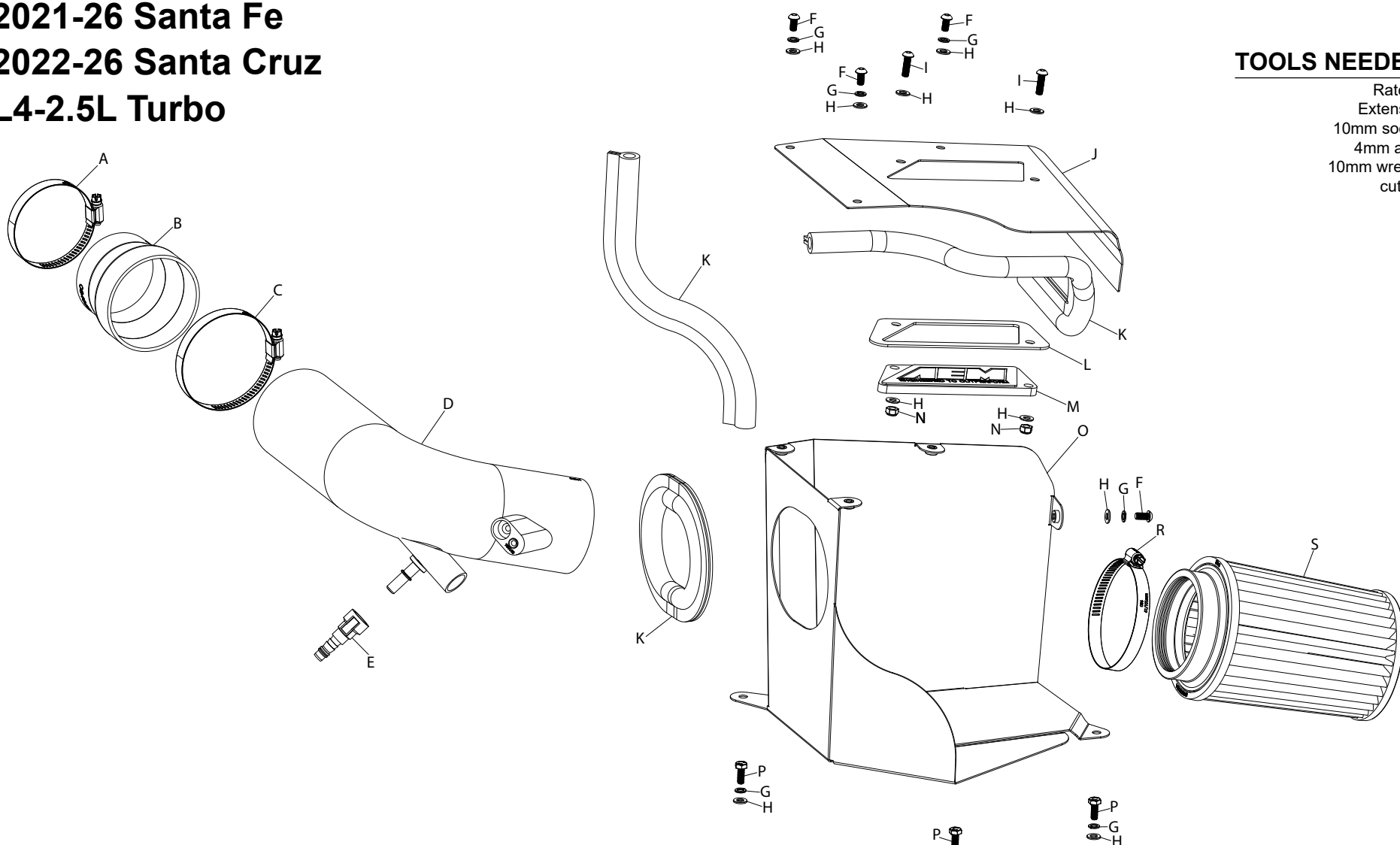

PARTS LIST:

Description	Qty.	Part #	Description	Qty.	Part #	Description	Qty.	Part #
A HOSE CLAMP; #48	1	08601	H WASHER; 6MM FLAT	11	08269	O HEAT SHIELD	1	074543
B HOSE; 3.5" TO 3"ID X 3"L	1	084055	I BOLT; M6 X 1 X 16MM BTNHD	2	07730	P BOLT; M6-1 X 16MM, HEX	3	07812
C HOSE CLAMP; #56	1	08620	J LID	1	074542	Q MOUNT; PLASTIC AIRBOX	1	8-186-1
D TUBE; 3.5"OD X 18"L, (AL)	1	25861C	K EDGE TRIM; (61"L)	1	102492	R 1/2" BNDHOSE CLAMP	1	9456
E FITTING; 3/8ID QC. TO 3/8BARB	1	082629	L SPACER; BADGE, CLEAR	1	7-364	S AIR FILTER	1	21-2047DK
F BOLT; M6-1 X 12MM BTNHD	4	07794	M PLATE; AEM LOGO CLEAR	1	8-211-1			
G WASHER; M6 SPLIT LOCK	7	1-3025	N NUT; 6MM NYLOCK, HEXHD	2	07512			

If you need any assistance please call 1-800-858-3333 to speak with a representative in our Customer Service Center before returning the product.

Read and understand these instructions BEFORE attempting to install this product. Failure to follow installation instructions and not using the provided hardware may damage the intake tube, throttle body and engine.

TO START:

1. Turn off the ignition and disconnect the negative battery cable.

NOTE: Disconnecting the negative battery cable erases pre-programmed electronic memories. Write down all memory settings before disconnecting the negative battery cable. Some radios will require an anti-theft code to be entered after the battery is reconnected. The anti-theft code is typically supplied with your owner's manual. In the event your vehicles anti-theft code cannot be recovered, contact an authorized dealership to obtain your vehicles anti-theft code.

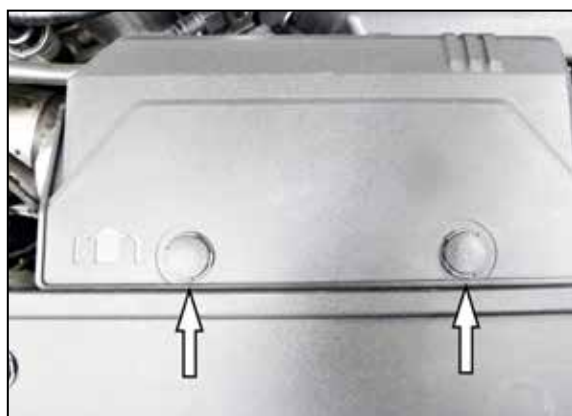

2. Pop up the center of the locking pins that secure the fresh air intake duct and then remove the pins and the fresh air duct.



3. Depress the locking buttons on the vent lines attached to the ejector fitting and then disconnect the vent lines from the fitting.



4. Spread the retaining spring securing the charge tube to the intercooler and then disconnect the tube from the cooler.



5. Release the spring clamp and then disconnect the BOV hose. Depress the locking button on the vent line and then disconnect the vent line.



6. Loosen the hose clamps that secure the factory intake tube and then remove the intake tube from the vehicle.



7. Remove the front air filter housing mounting bolt shown.



8. Remove the rear air filter housing mounting bolt shown. Remove the air filter housing from the vehicle.

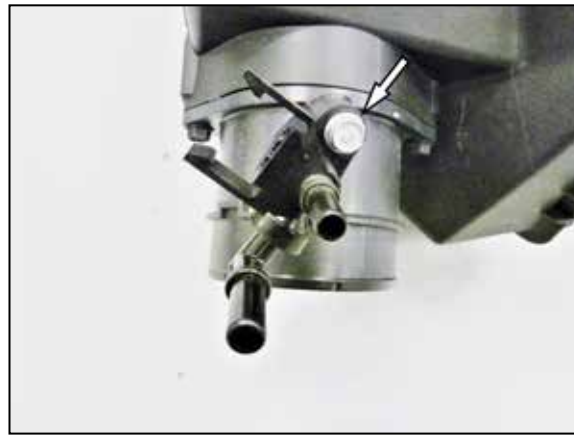

9. Remove the bolt that secures the ejector fitting to the air filter housing and then remove the fitting.



10. Install the ejector fitting onto the AEM intake tube and secure with the factory bolt.



11. Cut the provided edge trim into sections of 5.5", 15", 17" and 21" long. Install the edge trim onto the heat shield as show.



12. Install the mounting stud onto the heat shield using the provided hardware.



13. Release the spring clamp and remove the 90degree quick connect fitting from step #5 and replace it with the straight quick connect fitting provided.



14. Install the heat shield into the vehicle and secure it to the factory air filter housing mounting location using the provided hardware.



15. Install the provided coupler onto the turbo inlet pipe and secure with the provided hose clamp.



16. Install the AEM intake tube through the heat shield and then into the coupler, adjust for best fit and then secure with the provided hose clamp.



17. Connect the BOV hose and vent line to the AEM intake tube.



18. Connect the vent lines to the ejector fitting.



19. Install the AEM air filter onto the intake tube and secure with the provided hose clamp.



20. Install the 21" edge trim onto the lid and then install the AEM window into the lid using the provided hardware.



21. Install the lid onto the heat shield and secure with the provided hardware.



22. Install the fresh air intake duct and secure with the factory retaining clips.



23. Reassemble Vehicle

Position the inlet pipes for the best fitment. Be sure that the pipes or any other components do not contact any part of the vehicle. Tighten the rubber mount, all bolts, and hose clamps. Check for proper hood clearance. Re-adjust pipes if necessary and re-tighten them. Inspect the engine bay for any loose tools and check that all fasteners that were moved or removed are properly tightened. Reconnect negative battery terminal and start engine. Let the vehicle idle for 3 minutes. Perform a final inspection before driving the vehicle.

Service and Maintenance

AEM Induction Systems requires cleaning the intake system's air filter element every 100,000 miles. When used in dusty or off-road environments, our filters will require cleaning more often. We recommend that you visually inspect your filter once every 25,000 miles to determine if the screen is still visible. When the screen is no longer visible some place on the filter element, it is time to clean it. To clean, purchase our Synthetic air filter cleaner, part number AEM-1-1000 and follow the easy instructions. Use window cleaner to clean your powder coated AEM® intake tube.

NOTE: DO NOT USE aluminum polish on powder coated AEM® intake tubes.

NOT LEGAL FOR SALE OR USE ON ANY POLLUTION CONTROLLED MOTOR VEHICLE IN CALIFORNIA OR STATES ADOPTING CALIFORNIA EMISSION PROCEDURES.

See aemintakes.com for CARB status on each part for a specific vehicle

AEM Air Intake System Warranty Policy

AEM® warrants that its intake systems will last for the life of your vehicle. AEM will not honor this warranty due to mechanical damage (i.e. improper installation or fitment), damage from misuse, accidents or flying debris. AEM will not warrant its powder coating if the finish has been cleaned with a hydrocarbon-based solvent. The powder coating should only be cleaned with a mild soap and water solution. Proof of purchase of both the vehicle and AEM intake system is required for redemption of a warranty claim.

This warranty is limited to the repair or replacement of the AEM part. In no event shall this warranty exceed the original purchase price of the AEM part nor shall AEM be responsible for special, incidental or consequential damages or cost incurred due to the failure of this product. Warranty claims to AEM must be transportation prepaid and accompanied with dated proof of purchase. This warranty applies only to the original purchaser of product and is nontransferable. Improper use or installation, use for racing, accident, abuse, unauthorized repairs or alterations voids this warranty. AEM disclaims any liability for consequential damages due to breach of any written or implied warranty on all products manufactured by AEM. Warranty returns will only be accepted by AEM when accompanied by a valid Return Merchandise Authorization (RMA) number. Credit for defective products will be issued pending inspection. Product must be received by AEM within 30 days of the date RMA is issued.

If you have a warranty issue, please call (800) 992-3000 and our customer service department will assist you. A proof of purchase is required for all AEM warranty claims.